

SS 4 AIR TEST TABLE

TIME (MIN:SEC) REQUIRED FOR PRESSURE DROP FROM 3 1/2 TO 2 1/2 PSIG WHEN TESTING ONE PIPE DIAMETER ONLY. INCREASE PRESSURE AS REQUIRED BY ENGINEER IF GROUNDWATER IS PRESENT.

LENGTH OF LINE, FEET	PIPE DIAMETER, INCHES							
	4	6	8	10	12	15	18	24
25	0:05	0:11	0:18	0:23	0:27	:32	0:36	0:45
50	0:09	0:21	0:36	0:45	0:54	1:03	1:12	1:48
75	0:14	0:32	0:54	1:23	1:21	1:35	1:48	2:42
100	0:18	0:42	1:12	1:30	1:48	2:06	2:24	3:00
125	0:23	0:53	1:30	1:53	2:15	2:38	3:00	3:45
150	0:27	1:03	1:48	2:15	2:42	3:09	3:36	4:30
175	0:32	1:14	2:06	2:38	3:09	3:41	4:12	5:15
200	0:36	1:24	2:24	3:00	3:36	4:12	4:48	6:00
225	0:41	1:35	2:42	3:23	4:03	4:44	5:24	6:45
250	0:45	1:45	3:00	3:45	4:30	5:15	6:00	7:30
275	0:50	1:56	3:18	4:08	4:57	5:47	6:36	8:15
300	0:54	2:06	3:36	4:30	5:24	6:18	7:12	9:00
350	1:03	2:27	4:12	5:15	6:18	7:21	8:24	10:30
400	1:12	2:48	4:48	6:00	7:12	8:24	9:36	12:00
450	1:21	3:09	5:24	6:45	8:06	9:27	10:48	13:30
500	1:30	3:30	6:00	7:30	9:00	10:30	12:00	15:00

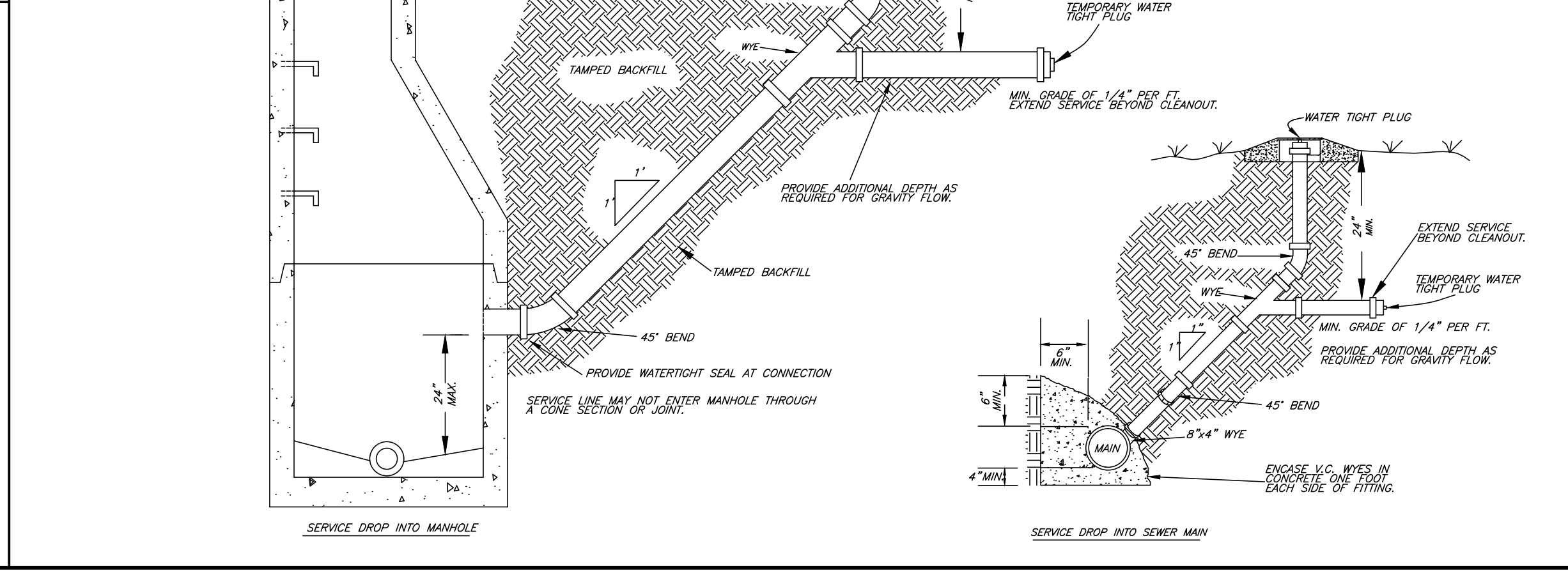
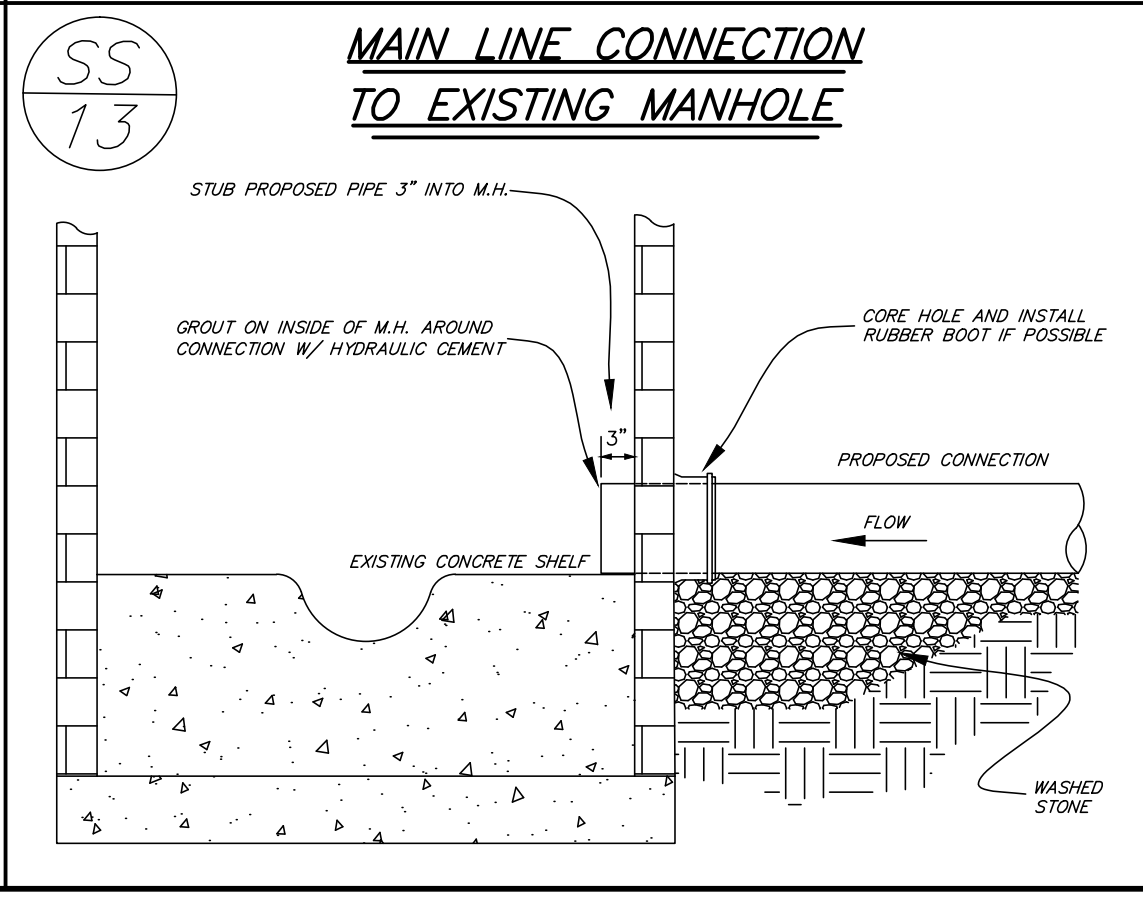
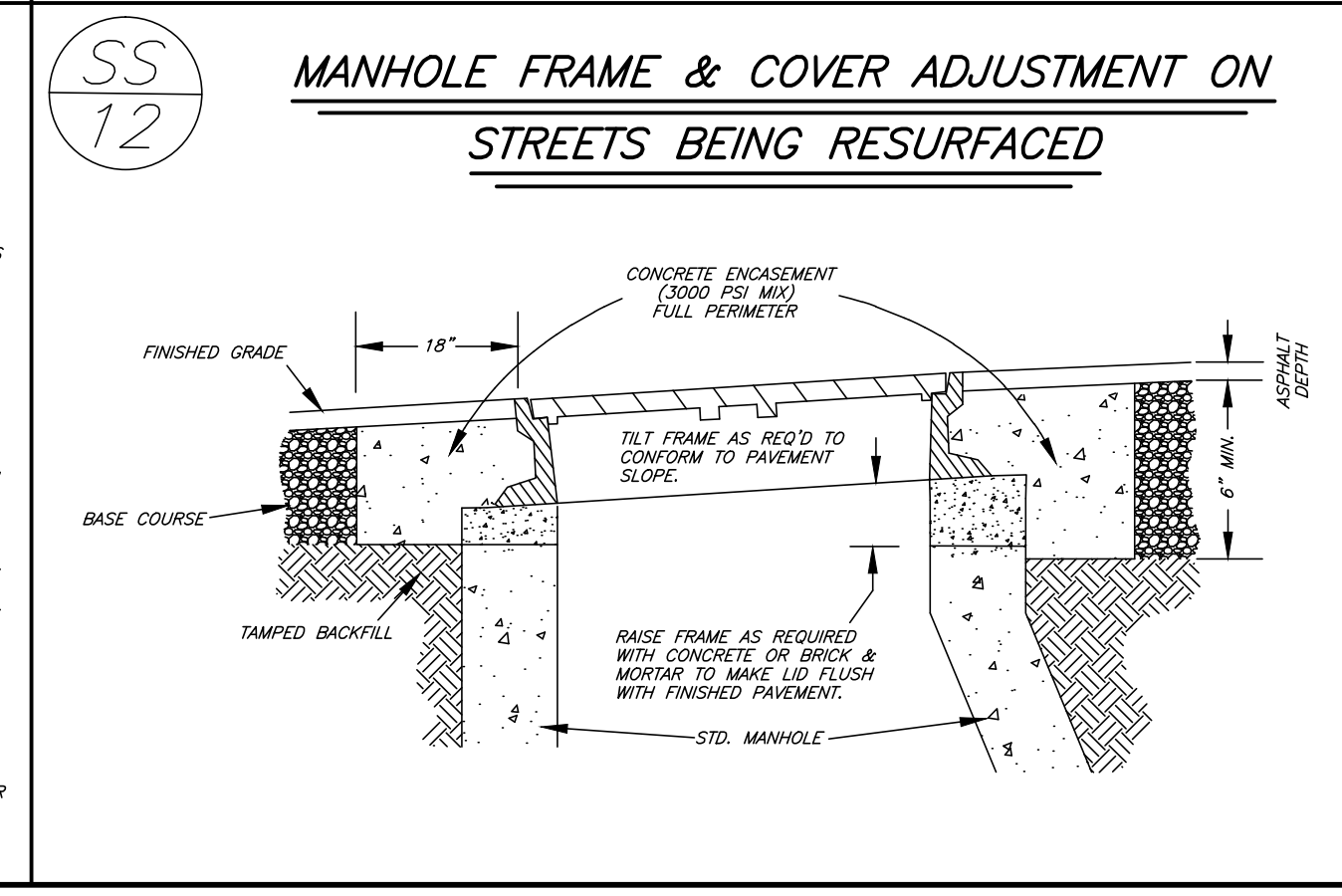
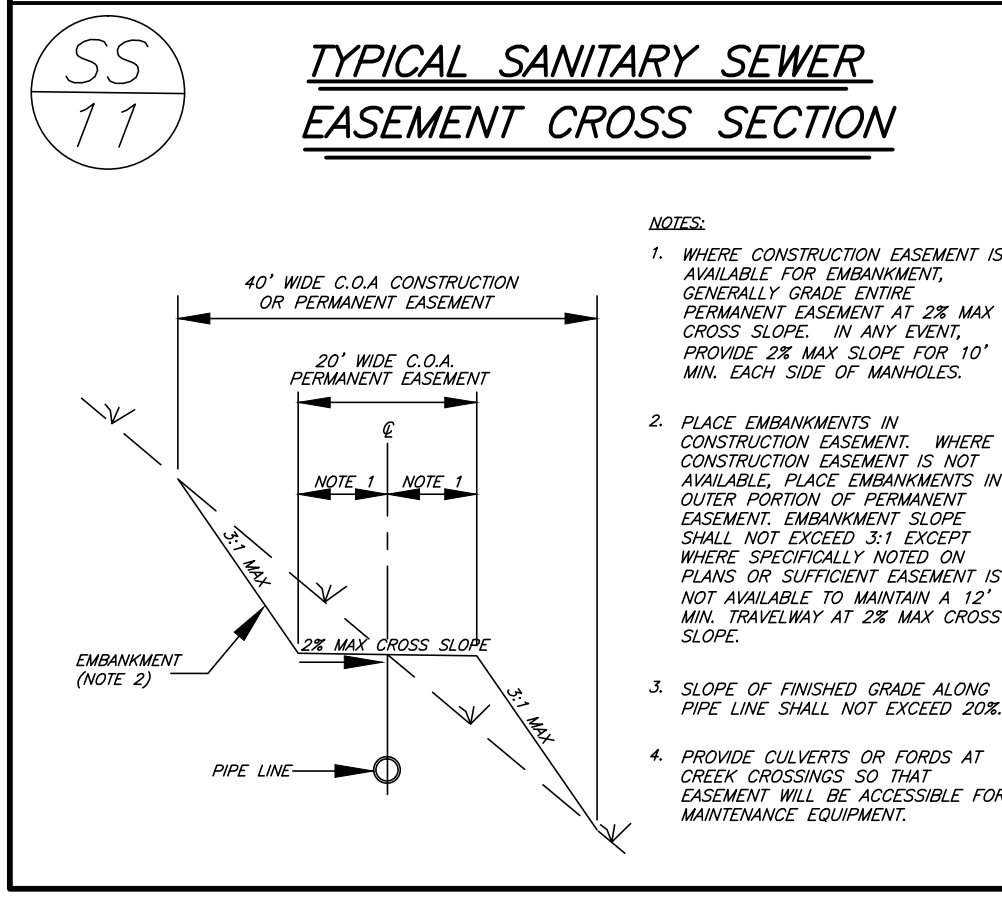
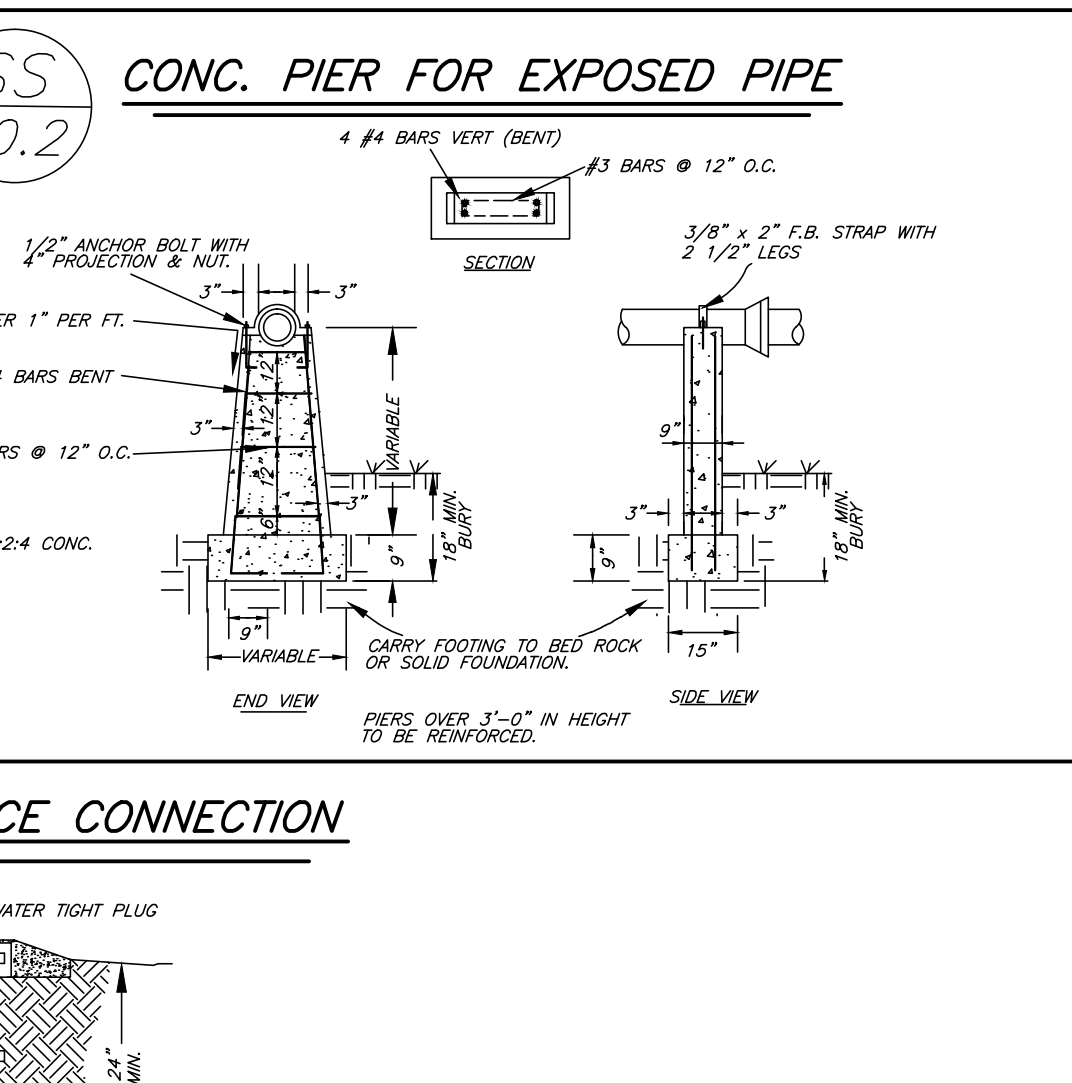
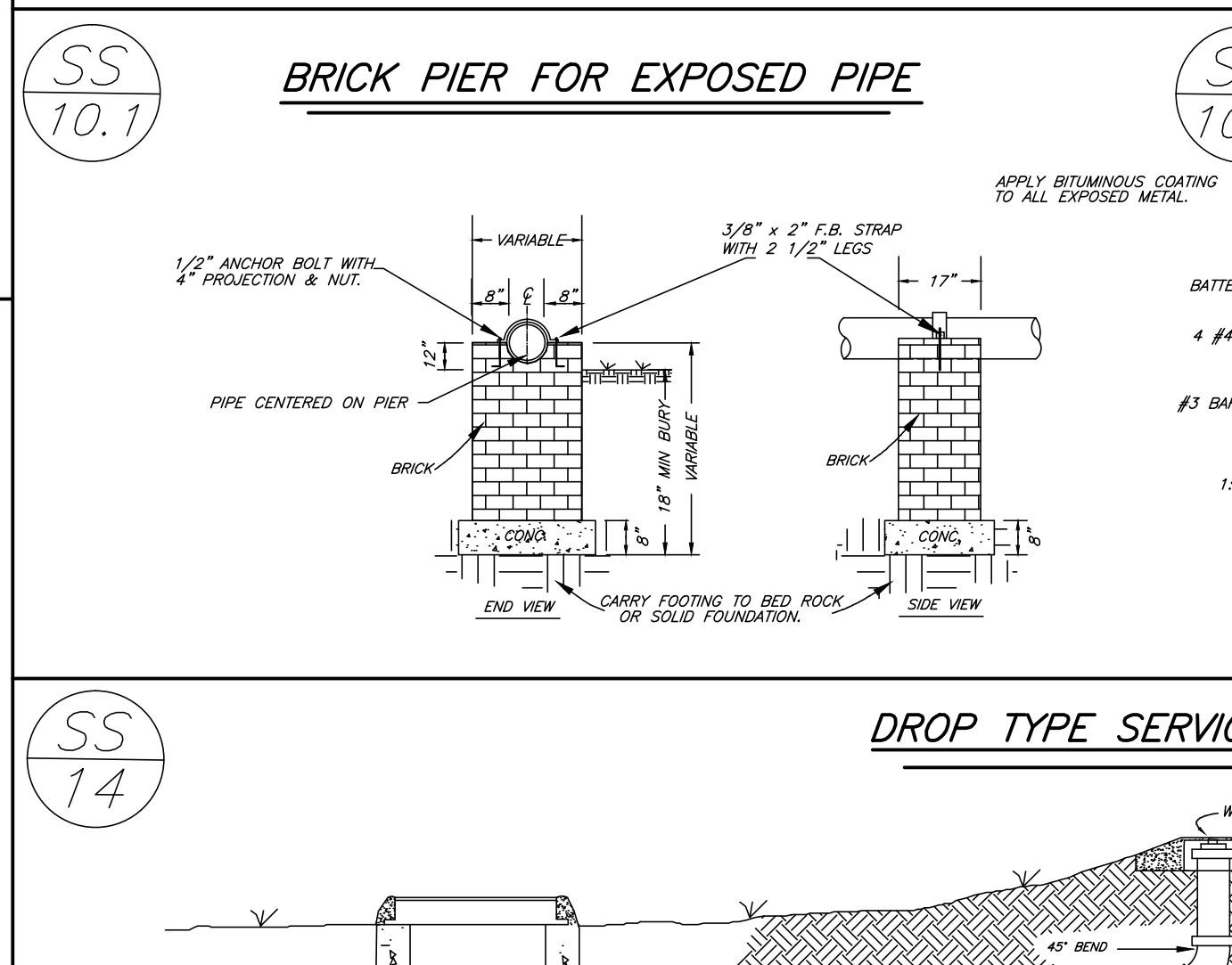
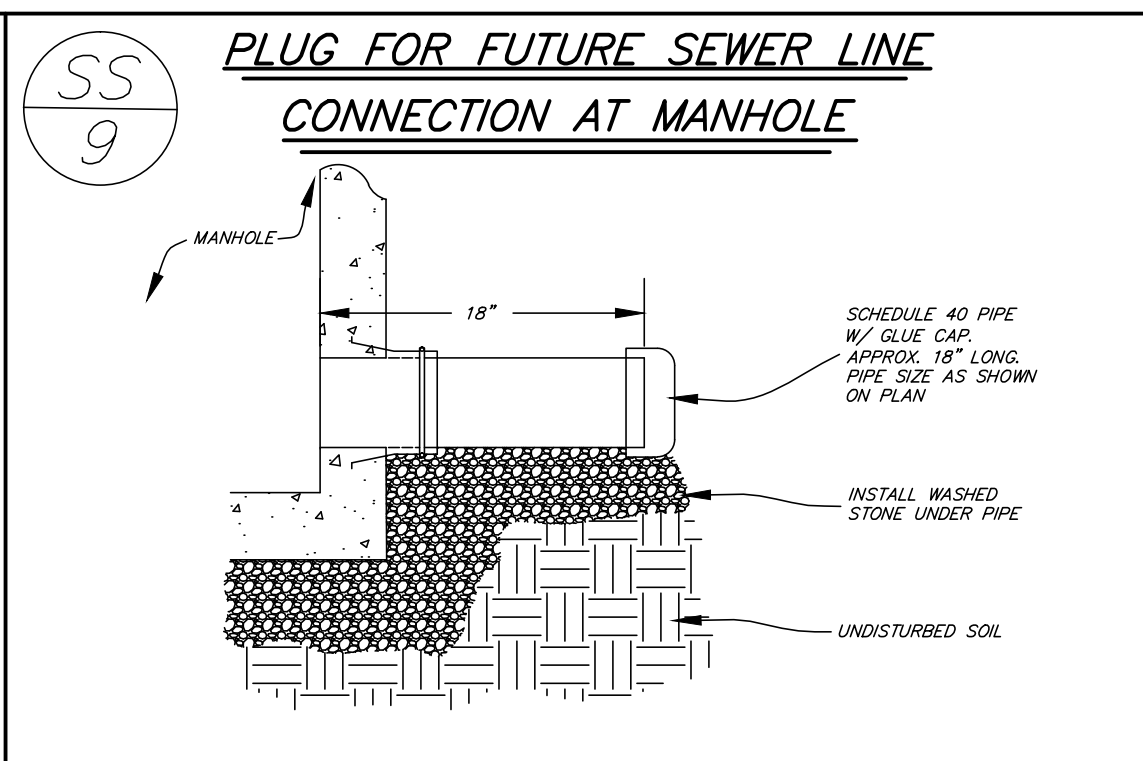
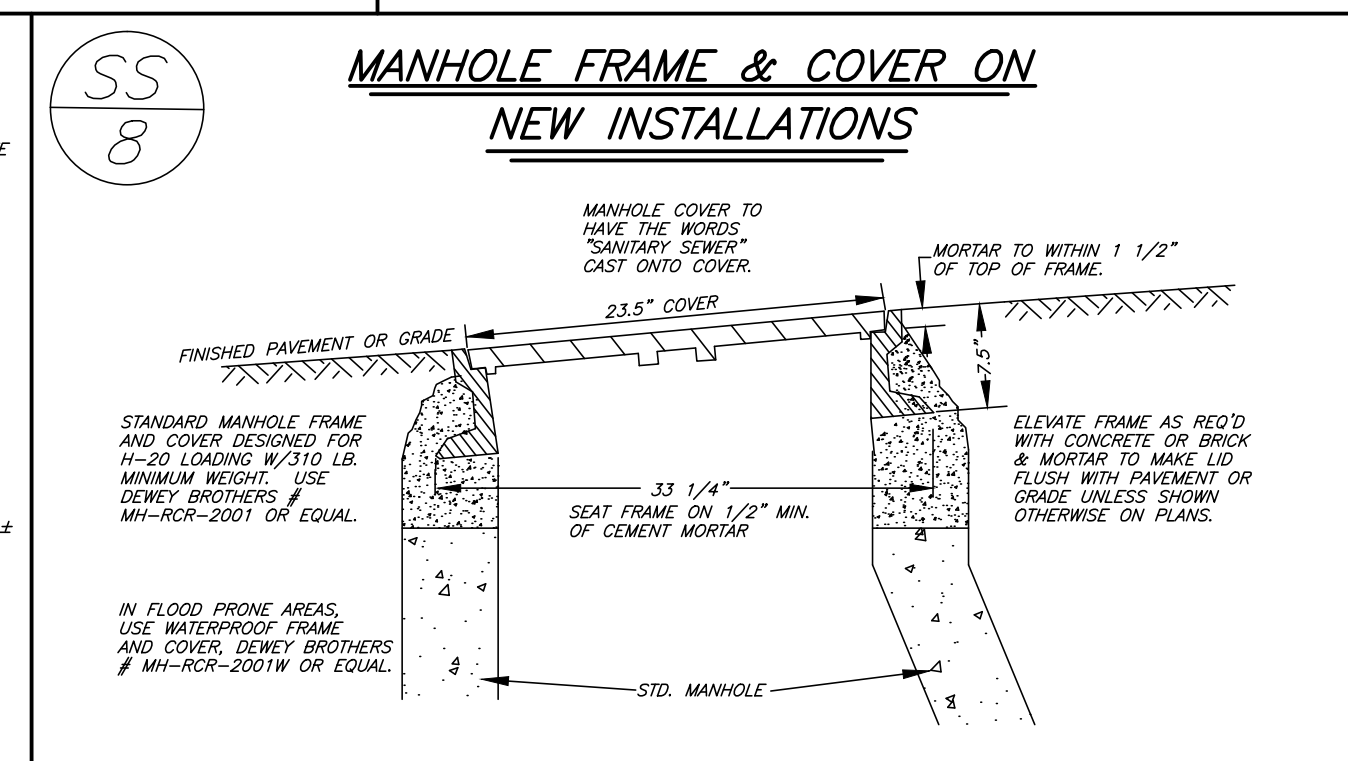
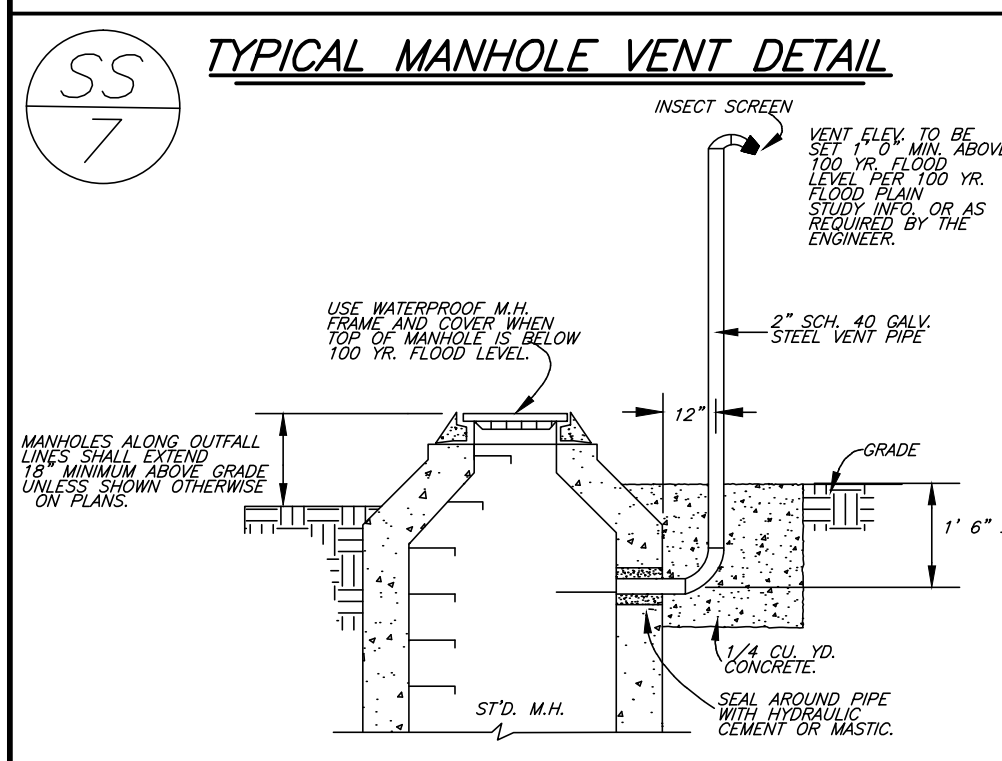
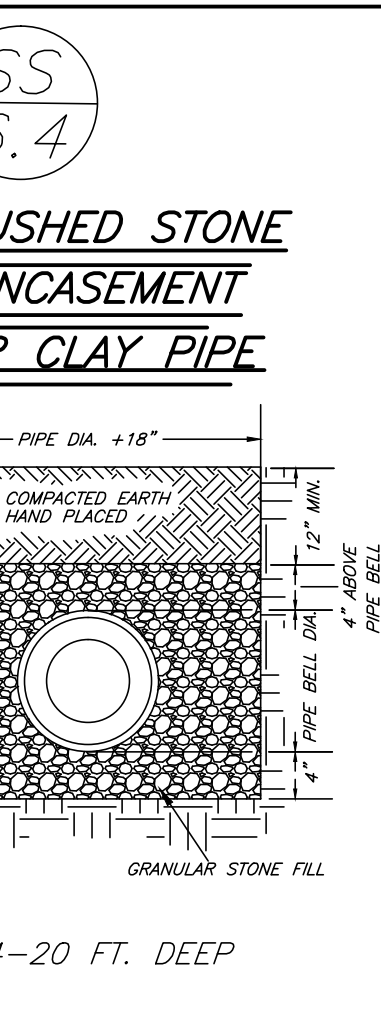
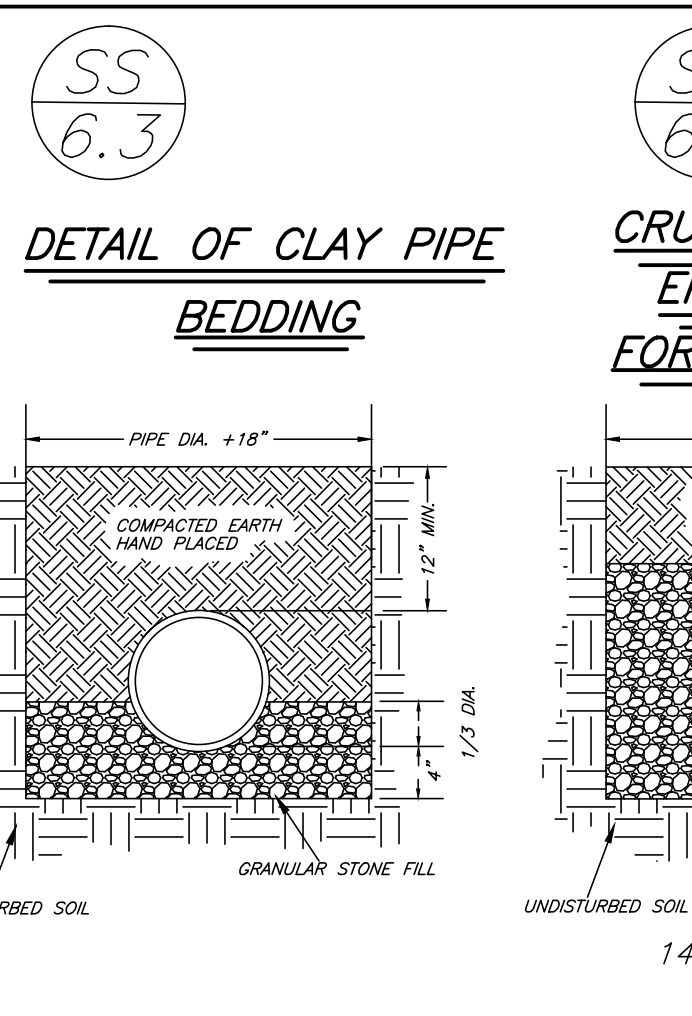
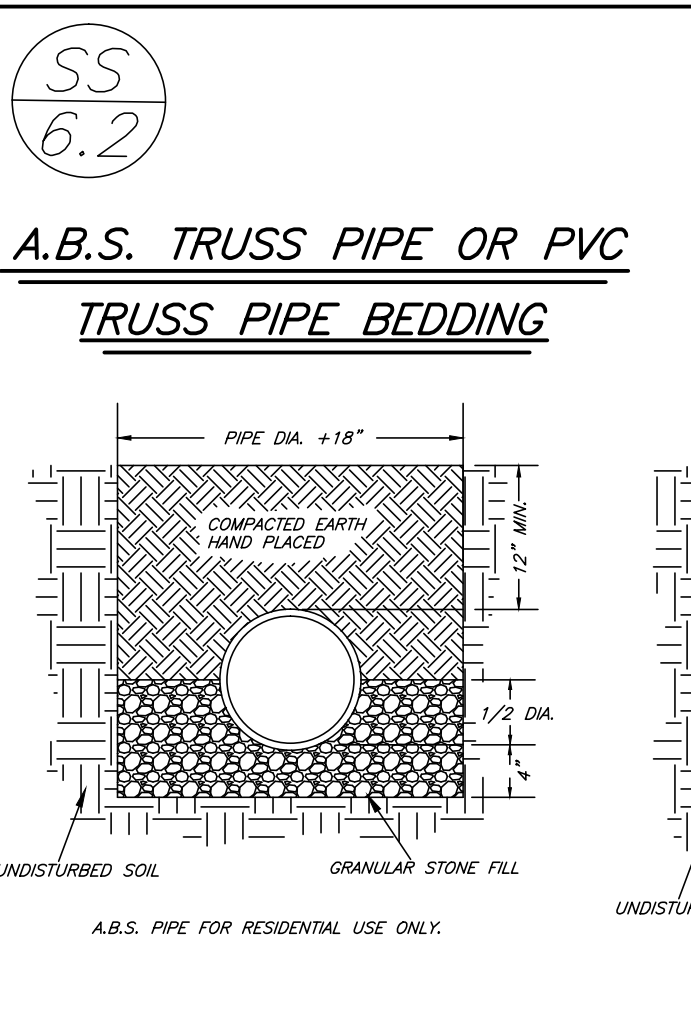
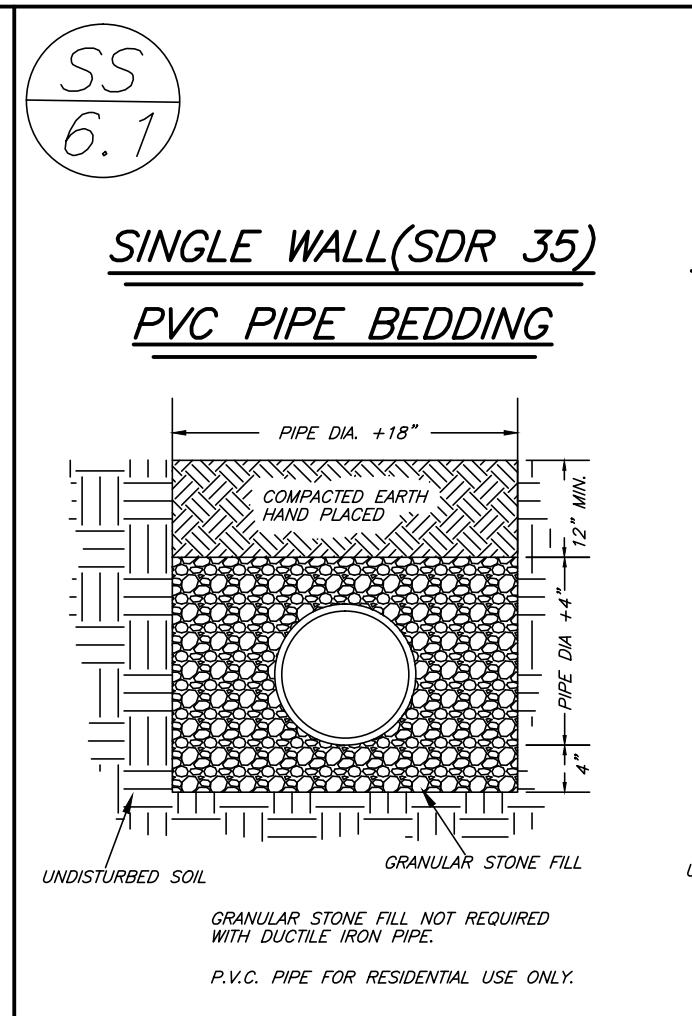
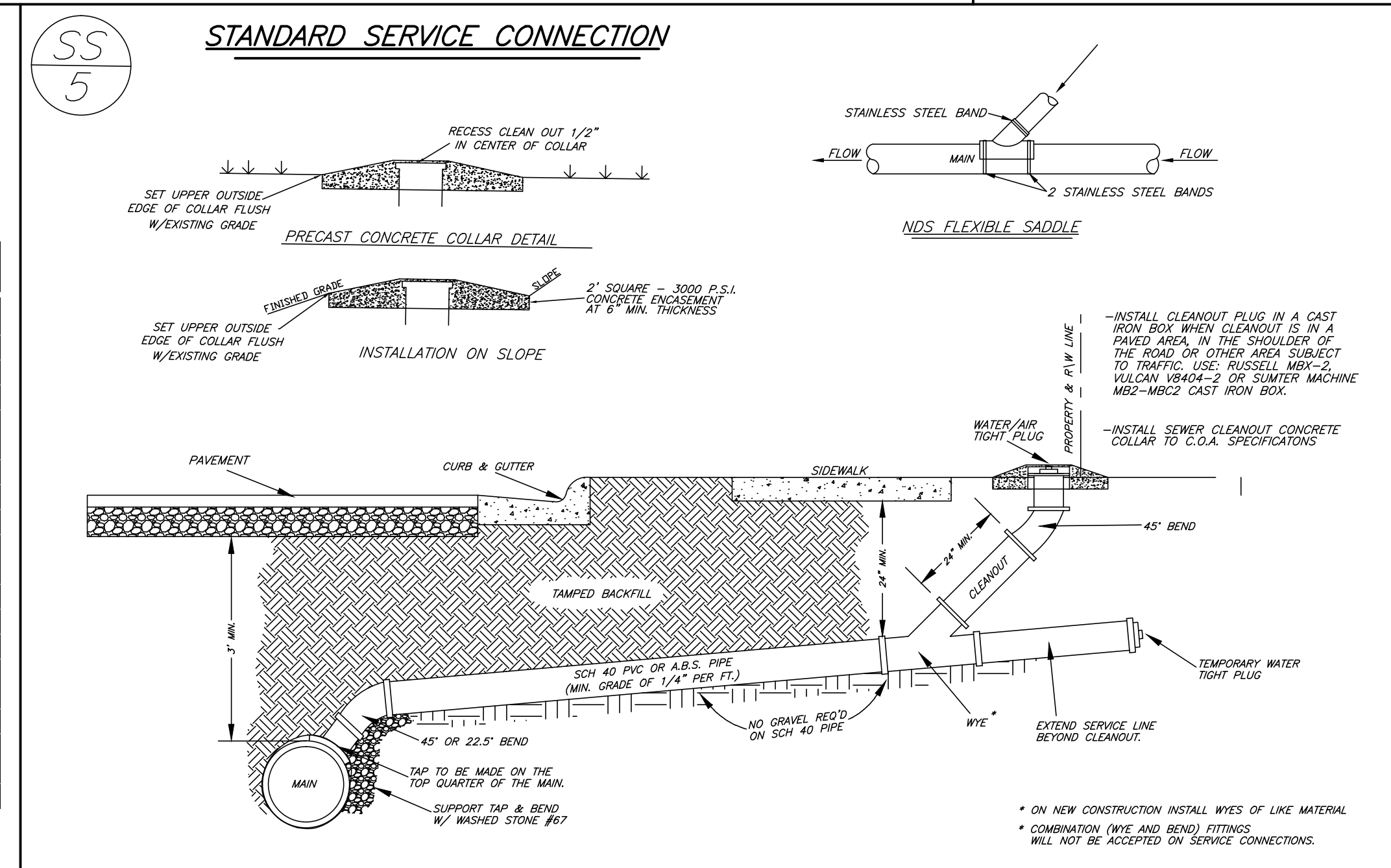

Date: _____
 Revisions: _____
 Mark: _____
 City of Asheboro
 Engineering Department
 146 North Church Street
 Asheboro, North Carolina
 Scale: Horiz. 1" = NONE
 Vert. 1" = NONE
 Date: 9/15
 Drawn By: MLL
 Checked By: _____
 Disk No. _____
 Drawing No. SANITARY
 Job No. SANITARY
 Sheet No. ? of ?